



Display CARFAX in online listings:



This report provided free of charge by:
Van Bortel Ford
71 Marsh Rd
East Rochester, NY 14445
585-460-1438

5X TOP-RATED DEALER
★ **4.8 / 5.0**
1,491 Verified Reviews

♥ **10,226**
Customer Favorites





Vehicle History Report™

US \$44.99

2015 SUBARU FORESTER 2.5I PREMIUM
VIN: JF2SJADC3FG496512
4 DOOR WAGON/SPORT UTILITY
2.5L H4 F DOHC 16V GASOLINE
ALL WHEEL DRIVE
This CARFAX Report Provided by:
Van Bortel Ford
★ **4.8 / 5.0**
1,491 Verified Reviews
♥ **10,226** Customer Favorites

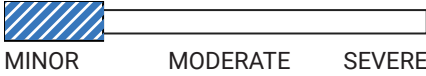
Damage reported: minor damage

 **20** Service history records

 **3** Previous owners

 Types of owners: Personal lease, Personal

 **93,271** Last reported odometer reading

This CARFAX Vehicle History Report is based only on information supplied to CARFAX and available as of 7/9/24 at 2:46:05 PM (CDT). Other information about this vehicle, including problems, may not have been reported to CARFAX. Use this report as one important tool, along with a vehicle inspection and test drive, to make a better decision about your next used car.



Accident / Damage History

Not all accidents / issues are reported to CARFAX

Event 1

11/12/2014
Damage reported: minor damage

Damage Severity Scale

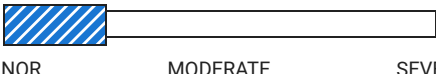

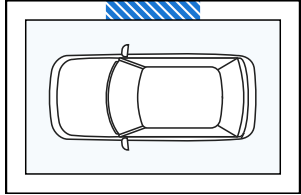

Event 2

07/18/2015

Damage reported: minor damage

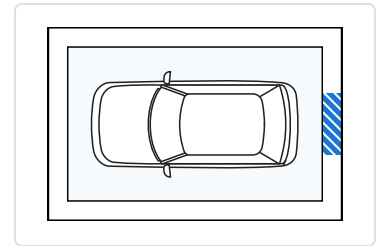
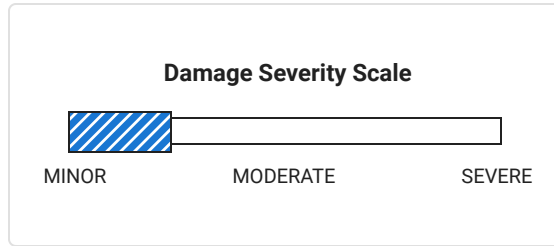

CARFAX Additional History Not all accidents / issues are reported to CARFAX	Owner 1	Owner 2	Owner 3
Total Loss No total loss reported to CARFAX.	✓ No Issues Reported	✓ No Issues Reported	✓ No Issues Reported
Structural Damage CARFAX recommends that you have this vehicle inspected by a collision repair specialist.	✓ No Issues Reported	✓ No Issues Reported	✓ No Issues Reported
Airbag Deployment No airbag deployment reported to CARFAX.	✓ No Issues Reported	✓ No Issues Reported	✓ No Issues Reported
Odometer Check No indication of an odometer rollback.	✓ No Issues Indicated	✓ No Issues Indicated	✓ No Issues Indicated
Accident / Damage Damage reported: 11/12/2014 and 07/18/2015.	Minor Damage	No New Issues Reported	No New Issues Reported
Manufacturer Recall Check with an authorized Subaru dealer for any open recalls.	✓ No Recalls Reported	✓ No Recalls Reported	✓ No Recalls Reported
Basic Warranty Original warranty estimated to have expired.	Warranty Expired	Warranty Expired	Warranty Expired

CARFAX Title History CARFAX guarantees the information in this section	Owner 1	Owner 2	Owner 3
Damage Brands Salvage Junk Rebuilt Fire Flood Hail Lemon	✓ Guaranteed No Problem	✓ Guaranteed No Problem	✓ Guaranteed No Problem
Odometer Brands Not Actual Mileage Exceeds Mechanical Limits	✓ Guaranteed No Problem	✓ Guaranteed No Problem	✓ Guaranteed No Problem



GUARANTEED - None of these title problems were reported by a U.S. state Department of Motor Vehicles (DMV). If you find that any of these title problems were reported by a DMV and not included in this report, you may qualify.
View Terms | View Certificate

CARFAX Ownership History The number of owners is estimated	Owner 1	Owner 2	Owner 3
Year purchased	2014	2017	2020
Type of owner	Personal lease	Personal	Personal
Estimated length of ownership	2 yrs. 11 mo.	2 yrs. 2 mo.	4 yrs. 3 mo.
Owned in the following states/provinces	New York	New York	New York
Estimated miles driven per year	13,395/yr	12,352/yr	6,539/yr
Last reported odometer reading	39,630	68,395	93,271

CARFAX Detailed History



Owner 1
Purchased: 2014



Low mileage! This owner drove less than the industry average of 15,000 miles per year.

Personal Lease
Vehicle
13,395 mi/yr

Date	Mileage	Source	Comments
09/29/2014	3	West Herr KIA Orchard Park, NY 716-608-3374 westherrkia.com ★ 4.4 / 5.0 122 Verified Reviews ❤️ 94 Customer Favorites	Vehicle sold
09/30/2014	7	West Herr KIA Orchard Park, NY 716-608-3374 westherrkia.com ★ 4.4 / 5.0 122 Verified Reviews ❤️ 94 Customer Favorites	 Vehicle serviced - Pre-delivery inspection completed - Safety inspection performed - Emissions or safety inspection performed
09/30/2014		New York Inspection Station	Passed safety inspection - Passed emissions inspection
09/30/2014		New York	Registration issued or renewed

Motor Vehicle Dept.
Buffalo, NY

- Titled or registered as personal lease vehicle
- Passed safety inspection

10/01/2014

Service Plan Co.

Vehicle sold

10/31/2014

New York
Motor Vehicle Dept.
Fort Worth, TX

Title issued or updated

- First owner reported

11/12/2014

Damage Report



Damage reported: minor damage

- Damage to right side



**CARFAX HAS THE MOST
ACCIDENT & DAMAGE
INFORMATION**

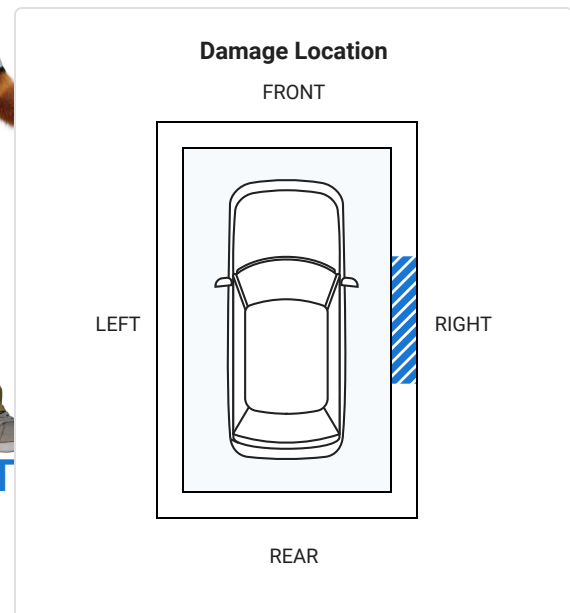
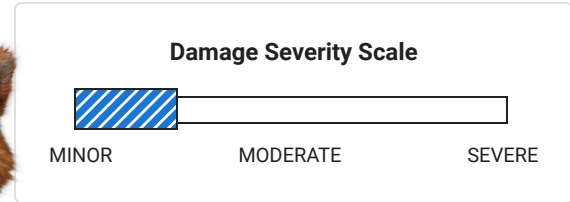

Minor damage is usually cosmetic, including dents or scratches to the vehicle body.



07/18/2015

Damage Report



Damage reported: minor damage

- Damage to rear

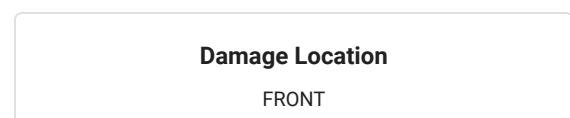
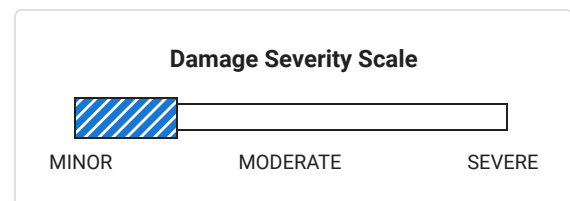

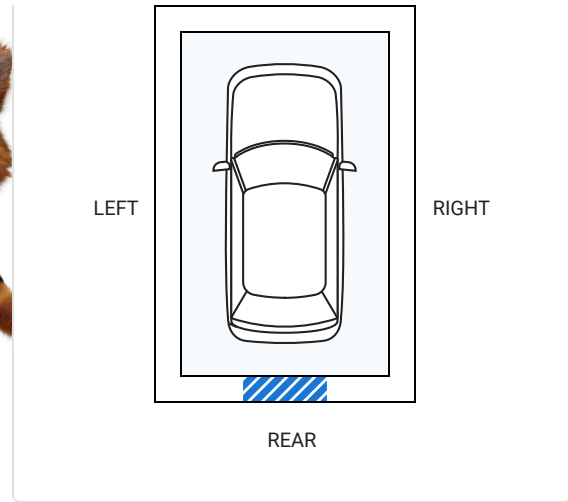



CARFAX HAS THE MOST ACCIDENT & DAMAGE INFORMATION



Minor damage is usually cosmetic, including dents or scratches to the vehicle body.

08/21/2015	14,558	Valvoline Instant Oil Change Buffalo, NY 716-874-5523 vioc.com ★ 4.6 / 5.0 108 Verified Reviews ❤️ 180 Customer Favorites	 Vehicle serviced - Oil and filter changed
09/29/2015	16,422	New York Inspection Station	Passed safety inspection - Emissions inspection performed
06/23/2016		New York Motor Vehicle Dept. Tully, NY	Registration issued or renewed - Passed safety inspection
10/01/2016	29,540	New York Inspection Station	Passed safety inspection - Emissions inspection performed
07/28/2017	37,654	Valvoline Instant Oil Change Buffalo, NY 716-874-5523 vioc.com ★ 4.6 / 5.0 108 Verified Reviews	 Vehicle serviced - Oil and filter changed - Cabin air filter replaced/cleaned

♥ 180 Customer Favorites

09/02/2017	39,195	Dealer Inventory	Vehicle offered for sale
09/07/2017		West Herr KIA Orchard Park, NY 716-608-3374 westherrkia.com ★ 4.4 / 5.0 122 Verified Reviews ♥ 94 Customer Favorites	 Vehicle serviced - Tire(s) balanced - Tires rotated - Oil and filter changed - Rear brake pads replaced - Emissions inspection performed
09/07/2017	39,206	New York Inspection Station	Passed safety inspection - Passed emissions inspection
09/12/2017	39,212	West Herr KIA Orchard Park, NY 716-608-3374 westherrkia.com ★ 4.4 / 5.0 122 Verified Reviews ♥ 94 Customer Favorites	Vehicle sold
09/12/2017		New York Motor Vehicle Dept. Buffalo, NY	Registration issued or renewed - Passed safety inspection
09/26/2017	39,630	Inspection Co.	Inspection performed





Owner 2

Purchased: 2017



Low mileage! This owner drove less than the industry average of 15,000 miles per year.

Personal Vehicle
12,352 mi/yr

Date	Mileage	Source	Comments
10/23/2017		New York Motor Vehicle Dept. Buffalo, NY	Title issued or updated - New owner reported - Loan or lien reported
03/03/2018	44,824	West Herr KIA Orchard Park, NY 716-608-3374 westherrkia.com ★ 4.4 / 5.0 122 Verified Reviews ♥ 94 Customer Favorites	 Vehicle serviced - Maintenance inspection completed - Oil and filter changed
07/20/2018	50,295	West Herr KIA Orchard Park, NY 716-608-3374 westherrkia.com	 Vehicle serviced - Maintenance inspection completed - Air filter replaced - Oil and filter changed

★ 4.4 / 5.0
122 Verified Reviews
♥ 94 Customer Favorites

09/29/2018 52,614 New York Inspection Station **Passed safety inspection**
- Passed emissions inspection

12/22/2018 55,512 West Herr KIA Orchard Park, NY 716-608-3374 westherrkia.com
★ 4.4 / 5.0
122 Verified Reviews
♥ 94 Customer Favorites

 **Vehicle serviced**
- Maintenance inspection completed
- Oil and filter changed

06/30/2019 New York Motor Vehicle Dept. Buffalo, NY **Registration issued or renewed**
- Titled or registered as personal vehicle
- Passed safety inspection

07/31/2019 64,009 West Herr KIA Orchard Park, NY 716-608-3374 westherrkia.com
★ 4.4 / 5.0
122 Verified Reviews
♥ 94 Customer Favorites

 **Vehicle serviced**
- Maintenance inspection completed
- Oil and filter changed
- Brake light switch replaced

09/30/2019 64,996 West Herr KIA Orchard Park, NY 716-608-3374 westherrkia.com
★ 4.4 / 5.0
122 Verified Reviews
♥ 94 Customer Favorites

 **Vehicle serviced**
- Maintenance inspection completed

10/12/2019 New York Inspection Station **Passed safety inspection**
- Passed emissions inspection

11/19/2019 64,997 West Herr KIA Orchard Park, NY 716-608-3374 westherrkia.com
★ 4.4 / 5.0
122 Verified Reviews
♥ 94 Customer Favorites

 **Vehicle serviced**

11/29/2019 67,904 Basil Toyota Lockport, NY 716-625-8444 basiltoyota.com
★ 4.5 / 5.0
204 Verified Reviews

 **Vehicle serviced**
- Maintenance inspection completed
- Four tires balanced
- Four tires mounted
- Air filter replaced
- Tire(s) replaced

♥ 1,470 Customer Favorites

- Fluids checked
- Oil and filter changed
- Vehicle washed/detailed

01/14/2020 67,905

Basil Toyota
Lockport, NY
716-625-8444
basiltoyota.com/

★ 4.5 / 5.0

204 Verified Reviews

♥ 1,470 Customer Favorites

Vehicle sold

02/01/2020 67,970

Basil Toyota
Lockport, NY
716-625-8444
basiltoyota.com

★ 4.5 / 5.0

204 Verified Reviews

♥ 1,470 Customer Favorites



Vehicle serviced

- Battery/charging system checked
- Vehicle washed/detailed
- Exterior light bulb(s) replaced
- Emissions inspection performed

02/03/2020

Basil Toyota
Lockport, NY
716-625-8444
basiltoyota.com/

★ 4.5 / 5.0

204 Verified Reviews

♥ 1,470 Customer Favorites

Vehicle sold

02/03/2020

New York
Inspection Station

Passed safety inspection

- Failed emissions inspection

02/04/2020 68,039

New York
Inspection Station

Passed safety inspection

- Passed emissions inspection

02/04/2020

New York
Motor Vehicle Dept.
Buffalo, NY

Registration issued or renewed

- Titled or registered as personal vehicle
- Passed safety inspection

02/14/2020 68,395

Inspection Co.

Inspection performed



Owner 3

Purchased: 2020



Low mileage! This owner drove less than the industry average of 15,000 miles per year.

Personal Vehicle
6,539 mi/yr

Date

Mileage

Source

Comments

03/10/2020

New York
Motor Vehicle Dept.
Buffalo, NY





Title issued or updated

- New owner reported

11/10/2020

New York

Registration issued or renewed

		Motor Vehicle Dept. Buffalo, NY		- Titled or registered as personal vehicle - Passed safety inspection
02/01/2021	73,043	New York Inspection Station		Passed safety inspection - Failed emissions inspection - Passed emissions inspection
06/30/2021	74,313	Bison Automotive & Detail, Inc. Buffalo, NY 716-873-1193 bisonautomotive.com ★ 4.8 / 5.0 100 Verified Reviews ❤️ 557 Customer Favorites		Vehicle serviced - A/C refrigerant recharged - Refrigerant added for leak check checked - Cabin air filter replaced/cleaned
09/11/2021	75,567	Valvoline Instant Oil Change Buffalo, NY 716-874-5523 vioc.com ★ 4.6 / 5.0 108 Verified Reviews ❤️ 180 Customer Favorites		Vehicle serviced - Oil and filter changed
12/20/2021	78,827	T-N-T Express Lube Inc East Aurora, NY 716-652-0170 ★ 4.6 / 5.0 85 Verified Reviews ❤️ 41 Customer Favorites		Vehicle serviced - Oil and filter changed
04/25/2022	82,390	New York Inspection Station		Passed safety inspection - Passed emissions inspection
05/05/2022	82,588	T-N-T Express Lube Inc East Aurora, NY 716-652-0170 ★ 4.6 / 5.0 85 Verified Reviews ❤️ 41 Customer Favorites		Vehicle serviced - Oil and filter changed
06/13/2022	83,490	Bison Automotive & Detail, Inc. Buffalo, NY 716-873-1193 bisonautomotive.com ★ 4.8 / 5.0 100 Verified Reviews ❤️ 557 Customer Favorites		Vehicle serviced - Oil and filter changed
12/13/2022		New York		Registration issued or renewed

Motor Vehicle Dept.
Buffalo, NY

- Titled or registered as personal vehicle
- Passed safety inspection
- Registration updated when owner moved the vehicle to a new location

12/17/2022 87,574

Valvoline Instant Oil
Change
Tonawanda, NY
716-877-9449
vioc.com



Vehicle serviced

- Oil and filter changed
- Air filter replaced

★ 4.7 / 5.0

96 Verified Reviews

♥ 99 Customer Favorites

07/07/2023 90,232

New York
Inspection Station

Passed safety inspection

- Failed emissions inspection
- Passed emissions inspection

07/14/2023

Bison Automotive &
Detail, Inc.
Buffalo, NY
716-873-1193
bisonautomotive.com



Vehicle serviced

- Idler pulley replaced
- Serpentine belt replaced
- Wiper(s) replaced
- Drive belt tensioner replaced
- Noise checked
- Wheel bearing(s)/hub(s) replaced
- Four wheel alignment performed
- Oil and filter changed
- Battery replaced
- Safety inspection performed
- Drain plug gasket replaced
- Tires rotated
- Emissions inspection performed

★ 4.8 / 5.0

100 Verified Reviews

♥ 557 Customer Favorites

03/06/2024 93,271

Bison Automotive &
Detail, Inc.
Buffalo, NY
716-873-1193
bisonautomotive.com



Vehicle serviced

- Oil and filter changed

★ 4.8 / 5.0

100 Verified Reviews

♥ 557 Customer Favorites

Have Questions? Consumers, please visit our Help Center at www.carfax.com. Dealers or Subscribers, please visit our Help Center at www.carfaxonline.com.



Glossary

Damage Indicator

Damage can be a result of many different types of events. Examples include contact with objects (other cars, trees, traffic signs, road debris, etc), vandalism, or weather-related events. Not every damage event is reported to CARFAX. As details about the damage event become available, those additional details are added to the CARFAX Vehicle History Report. CARFAX recommends that you have this vehicle inspected by a qualified mechanic.

- This CARFAX Vehicle History Report is based only on information supplied to CARFAX and available as of 7/9/24 at 2:46:05 PM (CDT). Other information about this vehicle, including problems, may not have been reported to CARFAX. Use this report as one important tool, along with a vehicle inspection and test drive, to make a better decision about your next used car.

Damage Severity

Damage events result in one of the following severity levels:

- Minor: Generally, minor damage is cosmetic (including dents or scratches), may only require reconditioning, and typically does not compromise a vehicle's operation and/or safety.
- Moderate: Moderate damage may affect multiple components of the vehicle and may impair the vehicle's operation and/or safety.
- Severe: Severe damage usually affects multiple components of the vehicle and is likely to compromise the vehicle's operation and/or safety.

CARFAX recommends getting a pre-purchase inspection at a certified collision repair facility.

Failed Emissions Inspection

The emissions check performed during a vehicle inspection indicated the vehicle was emitting more than allowable emissions standards and/or had missing or modified parts. Repeated failed emissions records can indicate engine problems and CARFAX recommends you have the vehicle inspected.

First Owner

When the first owner(s) obtains a title from a Department of Motor Vehicles as proof of ownership.

New Owner Reported

When a vehicle is sold to a new owner, the Title must be transferred to the new owner(s) at a Department of Motor Vehicles.

Ownership History

CARFAX defines an owner as an individual or business that possesses and uses a vehicle. Not all title transactions represent changes in ownership. To provide estimated number of owners, CARFAX proprietary technology analyzes all the events in a vehicle history. Estimated ownership is available for vehicles manufactured after 1991 and titled solely in the US including Puerto Rico. Dealers sometimes opt to take ownership of a vehicle and are required to in the following states: Maine, Massachusetts, New Jersey, Ohio, Oklahoma, Pennsylvania and South Dakota. Please consider this as you review a vehicle's estimated ownership history.

Title Issued

A state issues a title to provide a vehicle owner with proof of ownership. Each title has a unique number. Each title or registration record on a CARFAX report does not necessarily indicate a change in ownership. In Canada, a registration and bill of sale are used as proof of ownership.

Follow Us:



[facebook.com/CARFAX](https://www.facebook.com/CARFAX)



[@CARFAXinc](https://twitter.com/CARFAXinc)



About CARFAX

CARFAX DEPENDS ON ITS SOURCES FOR THE ACCURACY AND RELIABILITY OF ITS INFORMATION. THEREFORE, NO RESPONSIBILITY IS ASSUMED BY CARFAX OR ITS AGENTS FOR ERRORS OR OMISSIONS IN THIS REPORT. CARFAX FURTHER EXPRESSLY DISCLAIMS ALL WARRANTIES, EXPRESS OR IMPLIED, INCLUDING ANY IMPLIED WARRANTIES OF MERCHANTABILITY OR FITNESS FOR A PARTICULAR PURPOSE.

© 2024 CARFAX, Inc., part of S&P Global. All rights reserved.
7/9/24 2:46:05 PM (CDT)

I have reviewed and received a copy of the CARFAX Vehicle History Report for this 2015 SUBARU FORESTER vehicle (VIN: JF2SJADC3FG496512), which is based on information supplied to CARFAX and available as of 7/9/24 at 3:46 PM (EDT).

Customer Signature

Date

Dealer Signature

Date