













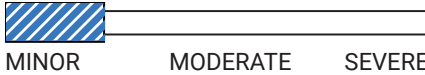

Display CARFAX in online listings:

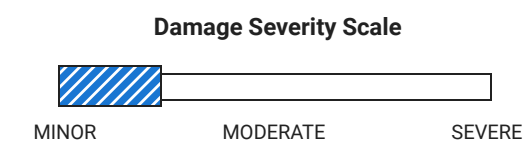
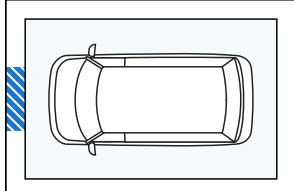

	This report provided free of charge by:	5X TOP-RATED DEALER	 10,210 Customer Favorites
	Van Bortel Ford 71 Marsh Rd East Rochester, NY 14445 585-460-1438	 4.8 / 5.0 1,485 Verified Reviews	

	Vehicle History Report™	US \$44.99
2018 HONDA ODYSSEY EX VIN: 5FNRL6H52JB052914 VAN 3.5L V6 F SOHC 24V GASOLINE FRONT WHEEL DRIVE	 Damage reported: minor damage 	
This CARFAX Report Provided by: Van Bortel Ford  4.8 / 5.0 1,485 Verified Reviews  10,210 Customer Favorites	 21 Service history records	
	 At least 1 open recall	
	 CARFAX 1-Owner vehicle	
	 58,706 Last reported odometer reading	

This CARFAX Vehicle History Report is based only on information supplied to CARFAX and available as of 6/27/24 at 12:16:15 PM (CDT). Other information about this vehicle, including problems, may not have been reported to CARFAX. Use this report as one important tool, along with a vehicle inspection and test drive, to make a better decision about your next used car.

	Accident / Damage History
Not all accidents / issues are reported to CARFAX	
Event 1	
03/23/2018 Damage reported: minor damage	 

 Additional History Not all accidents / issues are reported to CARFAX	Owner 1
Total Loss No total loss reported to CARFAX.	<input checked="" type="checkbox"/> No Issues Reported
Structural Damage CARFAX recommends that you have this vehicle inspected by a collision repair specialist.	<input checked="" type="checkbox"/> No Issues Reported
Airbag Deployment No airbag deployment reported to CARFAX.	<input checked="" type="checkbox"/> No Issues Reported
Odometer Check No indication of an odometer rollback.	<input checked="" type="checkbox"/> No Issues Indicated
Accident / Damage Damage reported: 03/23/2018.	Minor Damage
Manufacturer Recall At least 1 manufacturer recall requires service. Locate an authorized Honda dealer to obtain more information about this recall.	Recall Reported
Basic Warranty Original warranty estimated to have expired.	Warranty Expired

 Title History CARFAX guarantees the information in this section	Owner 1
Damage Brands Salvage Junk Rebuilt Fire Flood Hail Lemon	<input checked="" type="checkbox"/> Guaranteed No Problem
Odometer Brands Not Actual Mileage Exceeds Mechanical Limits	<input checked="" type="checkbox"/> Guaranteed No Problem
 GUARANTEED - None of these title problems were reported by a U.S. state Department of Motor Vehicles (DMV). If you find that any of these title problems were reported by a DMV and not included in this report, you may qualify. View Terms View Certificate	

 Ownership History The number of owners is estimated	Owner 1
Year purchased	2017
Type of owner	Personal
Estimated length of ownership	6 yrs. 7 mo.
Owned in the following states/provinces	New York
Estimated miles driven per year	9,014/yr



Last reported odometer reading

58,706



Detailed History

**Owner 1**

Purchased: 2017



Low mileage! This owner drove less than the industry average of 15,000 miles per year.

Personal Vehicle
9,014 mi/yr

Date	Mileage	Source		Comments
10/30/2017	7	Great Lakes Honda City Liverpool, NY 315-451-6750 greatlakeshondacity.com /		Vehicle serviced - Pre-delivery inspection completed
		★ 4.6 / 5.0 317 Verified Reviews		
		♥ 5,713 Customer Favorites		
11/01/2017		Dealer Inventory		Vehicle offered for sale
11/13/2017	17	Great Lakes Honda City Liverpool, NY 315-451-6750 greatlakeshondacity.com /		Vehicle serviced - Safety inspection performed - Emissions inspection performed - Emissions or safety inspection performed
		★ 4.6 / 5.0 317 Verified Reviews		
		♥ 5,713 Customer Favorites		
11/13/2017		New York Inspection Station		Passed safety inspection - Emissions inspection performed
11/13/2017		New York Motor Vehicle Dept. Liverpool, NY		Registration issued or renewed - Titled or registered as personal vehicle - Passed safety inspection
11/24/2017	240	Great Lakes Honda City Liverpool, NY 315-451-6750 greatlakeshondacity.com /		Vehicle serviced
		★ 4.6 / 5.0 317 Verified Reviews		
		♥ 5,713 Customer Favorites		
12/04/2017		New York Motor Vehicle Dept. Liverpool, NY		Title issued or updated - First owner reported - Titled or registered as personal vehicle

- Loan or lien reported

01/22/2018

New York
Motor Vehicle Dept.
Liverpool, NY

Registration issued or renewed

- Titled or registered as personal vehicle
- Passed safety inspection

03/23/2018

Damage Report



Damage reported: minor damage

- Damage to front



**CARFAX HAS THE MOST
ACCIDENT & DAMAGE
INFORMATION**

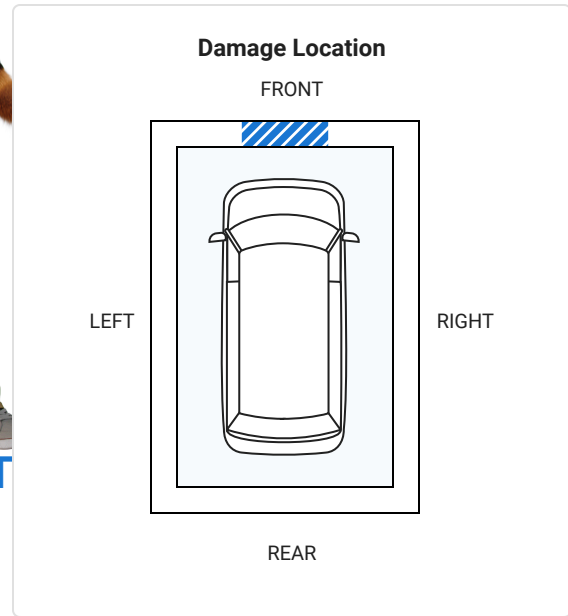
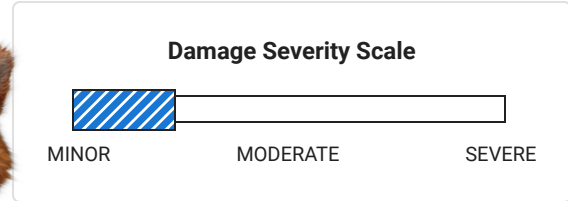

Minor damage is usually cosmetic, including dents or scratches to the vehicle body.

04/06/2018 3,193

Great Lakes Honda City
Liverpool, NY
315-451-6750
greatlakeshondacity.com
/



Vehicle serviced

- Maintenance inspection completed
- Tire(s) replaced
- Oil and filter changed
- Tire condition and pressure checked

★ 4.6 / 5.0

317 Verified Reviews





♥ 5,713 Customer Favorites

04/14/2018





New York
Motor Vehicle Dept.
Liverpool, NY





Registration issued or renewed

- Correction to record
- Titled or registered as personal vehicle
- Passed safety inspection

04/18/2018	Great Lakes Honda City Liverpool, NY 315-451-6750 greatlakeshondacity.com /		Vehicle serviced
<p>★ 4.6 / 5.0 317 Verified Reviews ♥ 5,713 Customer Favorites</p>			
11/10/2018 10,287	Great Lakes Honda City Liverpool, NY 315-451-6750 greatlakeshondacity.com /		Vehicle serviced - Maintenance inspection completed - Safety inspection performed - Tire(s) replaced - Oil and filter changed - Tire condition and pressure checked - Emissions inspection performed - Emissions or safety inspection performed
<p>★ 4.6 / 5.0 317 Verified Reviews ♥ 5,713 Customer Favorites</p>			
11/10/2018	New York Inspection Station		Passed safety inspection - Emissions inspection performed
12/31/2018	Great Lakes Honda City Liverpool, NY 315-451-6750 greatlakeshondacity.com /		Vehicle serviced - Back-up camera replaced
<p>★ 4.6 / 5.0 317 Verified Reviews ♥ 5,713 Customer Favorites</p>			
04/18/2019 13,967	Great Lakes Honda City Liverpool, NY 315-451-6750 greatlakeshondacity.com /		Vehicle serviced - Maintenance inspection completed - Tire(s) replaced - Oil and filter changed - Tire condition and pressure checked
<p>★ 4.6 / 5.0 317 Verified Reviews ♥ 5,713 Customer Favorites</p>			
10/24/2019 21,075	Great Lakes Honda City Liverpool, NY 315-451-6750 greatlakeshondacity.com /		Vehicle serviced - Maintenance inspection completed - Recommended maintenance performed - Safety inspection performed - Oil and filter changed - Tires rotated - Steering/suspension checked - Wipers/washers checked - Drivability/performance checked - Tire(s) replaced - Electrical system checked
<p>★ 4.6 / 5.0 317 Verified Reviews ♥ 5,713 Customer Favorites</p>			

- Sliding door checked
- Lights checked
- Emissions inspection performed
- Emissions or safety inspection performed

10/25/2019		New York Inspection Station		Passed safety inspection - Emissions inspection performed
12/23/2019	23,207	Great Lakes Honda City Liverpool, NY 315-451-6750 greatlakeshondacity.com / ★ 4.6 / 5.0 317 Verified Reviews ❤️ 5,713 Customer Favorites		Vehicle serviced - Sliding door checked
01/11/2020		New York Motor Vehicle Dept. Liverpool, NY		Registration issued or renewed - Titled or registered as personal vehicle - Passed safety inspection
04/13/2020	25,074	Great Lakes Honda City Liverpool, NY 315-451-6750 greatlakeshondacity.com / ★ 4.6 / 5.0 317 Verified Reviews ❤️ 5,713 Customer Favorites		Vehicle serviced - Maintenance inspection completed - Air filter replaced - Anti-theft/keyless remote battery replaced - Tire(s) replaced - Oil and filter changed - Tire condition and pressure checked - Cabin air filter replaced/cleaned
10/20/2020	27,839	Great Lakes Honda City Liverpool, NY 315-451-6750 greatlakeshondacity.com / ★ 4.6 / 5.0 317 Verified Reviews ❤️ 5,713 Customer Favorites		Vehicle serviced - Maintenance inspection completed - A/C freon conversion completed - Safety inspection performed - Oil and filter changed - Tire condition and pressure checked - Emissions inspection performed - Emissions or safety inspection performed
10/21/2020		New York Inspection Station		Passed safety inspection - Passed emissions inspection
07/22/2021	32,137	Great Lakes Honda City Liverpool, NY 315-451-6750 greatlakeshondacity.com / ★ 4.6 / 5.0 317 Verified Reviews ❤️ 5,713 Customer Favorites		Vehicle serviced - Rear brake pads replaced - Rear brake rotor(s) replaced - Front brake rotor(s) replaced - Front brake pads replaced - Brake rotor(s) replaced - Oil and filter changed

10/25/2021	33,912	Great Lakes Honda City Liverpool, NY 315-451-6750 greatlakeshondacity.com / ★ 4.6 / 5.0 317 Verified Reviews ♥ 5,713 Customer Favorites		Vehicle serviced - Safety inspection performed - Tire(s) replaced - Emissions inspection performed - Emissions or safety inspection performed
10/25/2021		New York Inspection Station		Passed safety inspection - Passed emissions inspection
01/03/2022		New York Motor Vehicle Dept. Liverpool, NY		Registration issued or renewed - Titled or registered as personal vehicle - Passed safety inspection
04/25/2022	37,669	Great Lakes Honda City Liverpool, NY 315-451-6750 greatlakeshondacity.com / ★ 4.6 / 5.0 317 Verified Reviews ♥ 5,713 Customer Favorites		Vehicle serviced - Oil and filter changed - Tire condition and pressure checked - Tire(s) replaced
10/21/2022	44,411	Great Lakes Honda City Liverpool, NY 315-451-6750 greatlakeshondacity.com / ★ 4.6 / 5.0 317 Verified Reviews ♥ 5,713 Customer Favorites		Vehicle serviced - Maintenance inspection completed - Air filter replaced - Tire(s) balanced - Tire(s) replaced - Fluids checked - Oil and filter changed - Cabin air filter replaced/cleaned - Emissions or safety inspection performed
10/21/2022		New York Inspection Station		Passed safety inspection - Passed emissions inspection
03/08/2023	47,791	Great Lakes Honda City Liverpool, NY 315-451-6750 greatlakeshondacity.com / ★ 4.6 / 5.0 317 Verified Reviews ♥ 5,713 Customer Favorites		Vehicle serviced
05/19/2023	50,772	Great Lakes Honda City Liverpool, NY 315-451-6750		Vehicle serviced - Fluids checked - Oil and filter changed - Tire condition and pressure checked

greatlakeshondacity.com /

★ 4.6 / 5.0

317 Verified Reviews

♥ 5,713 Customer Favorites

- Four tires balanced

06/16/2023

American Honda Motor Co.

Manufacturer Safety-related recall issued

- NHTSA #23V-431
- Recall #EEL 2018-23 Odyssey MOST FAKRA Service Cables Safety Recall
- Status: Remedy Available

Locate an authorized Honda dealer to obtain more information about this recall

⊖ [Learn more about this recall](#)

Description: American Honda Motor Co., Inc. (Honda) is recalling certain 2018-2023 model year Odyssey vehicles. The Media Oriented Systems Transport (MOST) communication coaxial cable was improperly designed and manufactured, resulting in deformed terminals and potentially causing poor, or lost, connections intermittently between the audio display unit and the vehicle cable connector.

If the MOST communication is lost for more than 20 seconds, the rearview camera function will fail when the vehicle is in the reverse gear, increasing the risk of a crash or injury.

Remedy: Registered owners of all affected vehicles will be contacted by mail and asked to take their vehicle to an authorized Honda dealer. The dealer will install an improved MOST cable harness between the existing display audio and vehicle terminal connections and a straightening cover over the vehicle cable connector to properly connect the audio display unit. Owners who have paid to have these repairs completed at their own expense may be eligible for reimbursement, in accord with the recall reimbursement plan on file with NHTSA. For additional questions, owners may contact American Honda's Customer Support & Campaign Center at 1-888-234-2138.

10/23/2023 53,757

Great Lakes Honda City
Liverpool, NY
315-451-6750
greatlakeshondacity.com /

★ 4.6 / 5.0

317 Verified Reviews

♥ 5,713 Customer Favorites



Vehicle serviced

- Four tires balanced
- Four tires mounted
- Fluids checked
- Oil and filter changed
- Tire condition and pressure checked

10/23/2023

New York
Inspection Station

Passed safety inspection

- Passed emissions inspection

12/05/2023

New York
Motor Vehicle Dept.
Liverpool, NY

Registration issued or renewed

- Titled or registered as personal vehicle
- Passed safety inspection

04/25/2024 57,883

Great Lakes Honda City
Liverpool, NY
315-451-6750
greatlakeshondacity.com
/



Vehicle serviced

- Maintenance inspection completed
- Four tires balanced
- Four tires mounted
- Fluids checked
- Oil and filter changed
- Tire condition and pressure checked

★ 4.6 / 5.0

317 Verified Reviews

♥ 5,713 Customer Favorites

05/17/2024 58,706

Great Lakes Honda City
Liverpool, NY
315-451-6750
greatlakeshondacity.com
/



Vehicle serviced

- Maintenance inspection completed

★ 4.6 / 5.0

317 Verified Reviews

♥ 5,713 Customer Favorites

Have Questions? Consumers, please visit our Help Center at www.carfax.com. Dealers or Subscribers, please visit our Help Center at www.carfaxonline.com.



Glossary

Damage Indicator

Damage can be a result of many different types of events. Examples include contact with objects (other cars, trees, traffic signs, road debris, etc), vandalism, or weather-related events. Not every damage event is reported to CARFAX. As details about the damage event become available, those additional details are added to the CARFAX Vehicle History Report. CARFAX recommends that you have this vehicle inspected by a qualified mechanic.

- This CARFAX Vehicle History Report is based only on information supplied to CARFAX and available as of 6/27/24 at 12:16:15 PM (CDT). Other information about this vehicle, including problems, may not have been reported to CARFAX. Use this report as one important tool, along with a vehicle inspection and test drive, to make a better decision about your next used car.

Damage Severity

Damage events result in one of the following severity levels:

- Minor: Generally, minor damage is cosmetic (including dents or scratches), may only require reconditioning, and typically does not compromise a vehicle's operation and/or safety.
- Moderate: Moderate damage may affect multiple components of the vehicle and may impair the vehicle's operation and/or safety.
- Severe: Severe damage usually affects multiple components of the vehicle and is likely to compromise the vehicle's operation and/or safety.

CARFAX recommends getting a pre-purchase inspection at a certified collision repair facility.

First Owner

When the first owner(s) obtains a title from a Department of Motor Vehicles as proof of ownership.

Manufacturer Recall

Automobile manufacturers issue recall notices to inform vehicle owners of a safety defect or failure to meet minimum federal safety or emissions standards. Manufacturer recalls are repaired at no cost to the customer.



Ownership History

CARFAX defines an owner as an individual or business that possesses and uses a vehicle. Not all title transactions represent changes in ownership. To provide estimated number of owners, CARFAX proprietary technology analyzes

all the events in a vehicle history. Estimated ownership is available for vehicles manufactured after 1991 and titled solely in the US including Puerto Rico. Dealers sometimes opt to take ownership of a vehicle and are required to in the following states: Maine, Massachusetts, New Jersey, Ohio, Oklahoma, Pennsylvania and South Dakota. Please consider this as you review a vehicle's estimated ownership history.

Title Issued

A state issues a title to provide a vehicle owner with proof of ownership. Each title has a unique number. Each title or registration record on a CARFAX report does not necessarily indicate a change in ownership. In Canada, a registration and bill of sale are used as proof of ownership.

Follow Us:  facebook.com/CARFAX  [@CARFAXinc](https://twitter.com/CARFAXinc)  **About CARFAX**

CARFAX DEPENDS ON ITS SOURCES FOR THE ACCURACY AND RELIABILITY OF ITS INFORMATION. THEREFORE, NO RESPONSIBILITY IS ASSUMED BY CARFAX OR ITS AGENTS FOR ERRORS OR OMISSIONS IN THIS REPORT. CARFAX FURTHER EXPRESSLY DISCLAIMS ALL WARRANTIES, EXPRESS OR IMPLIED, INCLUDING ANY IMPLIED WARRANTIES OF MERCHANTABILITY OR FITNESS FOR A PARTICULAR PURPOSE.

© 2024 CARFAX, Inc., part of S&P Global. All rights reserved.
6/27/24 12:16:15 PM (CDT)

I have reviewed and received a copy of the CARFAX Vehicle History Report for this 2018 HONDA ODYSSEY vehicle (VIN: 5FNRL6H52JB052914), which is based on information supplied to CARFAX and available as of 6/27/24 at 1:16 PM (EDT).

Customer Signature

Date

Dealer Signature

Date