







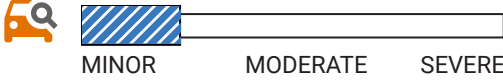

Display CARFAX in online listings:

	This report provided free of charge by: <b>Van Bortel Ford</b> 71 Marsh Rd East Rochester, NY 14445 585-460-1438	<b>5X TOP-RATED DEALER</b> <b>★ 4.8 / 5.0</b> 1,491 Verified Reviews	<b>♥ 10,226</b> Customer Favorites
---	--	--	---------------------------------------

	<b>Vehicle History Report™</b>	US \$44.99
<b>2012 TOYOTA RAV4</b> VIN: 2T3BF4DV6CW182453 4 DOOR WAGON/SPORT UTILITY 2.5L I4 F DOHC 16V GASOLINE ALL WHEEL DRIVE	<b>Accident reported: minor damage</b>  MINOR      MODERATE      SEVERE	
This CARFAX Report Provided by: <b>Van Bortel Ford</b> ★ 4.8 / 5.0 1,491 Verified Reviews ♥ 10,226 Customer Favorites	 <b>13</b> Service history records	
	 <b>4</b> Previous owners	
	 Types of owners: Rental, Personal, Personal lease	
	 <b>78,410</b> Last reported odometer reading	

This CARFAX Vehicle History Report is based only on information supplied to CARFAX and available as of 7/9/24 at 2:42:50 PM (CDT). Other information about this vehicle, including problems, may not have been reported to CARFAX. Use this report as one important tool, along with a vehicle inspection and test drive, to make a better decision about your next used car.

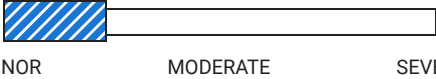
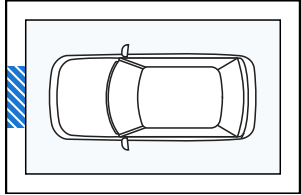
	<b>Accident / Damage History</b> Not all accidents / issues are reported to CARFAX
Event 1	
10/11/2012 <b>Accident reported: minor damage with another motor vehicle</b>	<b>Damage Severity Scale</b>  MINOR      MODERATE      SEVERE
	

Event 2

01/09/2018

**Damage reported: minor damage**

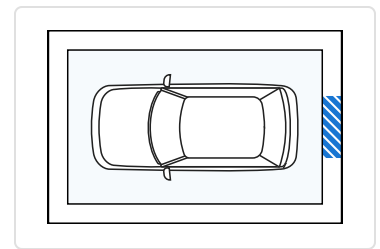
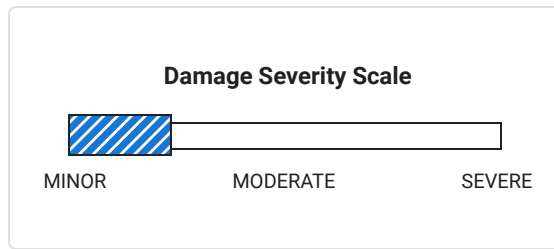

<b>CARFAX</b> Additional History Not all accidents / issues are reported to CARFAX	Owners 1-2	Owner 3	Owner 4
<b>Total Loss</b> No total loss reported to CARFAX.	✓ No Issues Reported	✓ No Issues Reported	✓ No Issues Reported
<b>Structural Damage</b> CARFAX recommends that you have this vehicle inspected by a collision repair specialist.	✓ No Issues Reported	✓ No Issues Reported	✓ No Issues Reported
<b>Airbag Deployment</b> No airbag deployment reported to CARFAX.	✓ No Issues Reported	✓ No Issues Reported	✓ No Issues Reported
<b>Odometer Check</b> No indication of an odometer rollback.	✓ No Issues Indicated	✓ No Issues Indicated	✓ No Issues Indicated
<b>Accident / Damage</b> Accident reported: 10/11/2012. Damage reported: 01/09/2018.	Minor Damage	No New Issues Reported	Minor Damage
<b>Manufacturer Recall</b> No open recalls reported to CARFAX. Check with an authorized Toyota dealer for any open recalls. View Toyota disclosure	✓ No Recalls Reported	✓ No Recalls Reported	✓ No Recalls Reported
<b>Basic Warranty</b> Original warranty estimated to have expired.	Warranty Expired	Warranty Expired	Warranty Expired

<b>CARFAX</b> Title History CARFAX guarantees the information in this section	Owners 1-2	Owner 3	Owner 4
<b>Damage Brands</b> Salvage   Junk   Rebuilt   Fire   Flood   Hail   Lemon	✓ <b>Guaranteed</b> No Problem	✓ <b>Guaranteed</b> No Problem	✓ <b>Guaranteed</b> No Problem
<b>Odometer Brands</b> Not Actual Mileage   Exceeds Mechanical Limits	✓ <b>Guaranteed</b> No Problem	✓ <b>Guaranteed</b> No Problem	✓ <b>Guaranteed</b> No Problem



**GUARANTEED** - None of these title problems were reported by a U.S. state Department of Motor Vehicles (DMV). If you find that any of these title problems were reported by a DMV and not included in this report, you may qualify.  
View Terms | View Certificate

<b>CARFAX</b> Ownership History The number of owners is estimated	Owners 1-2	Owner 3	Owner 4
Year purchased	2012	2015	2016
Type of owner	See Details	Personal lease	Personal
Estimated length of ownership	3 yrs. 8 mo.	1 month	8 yrs. 3 mo.
Owned in the following states/provinces	See Details	Indiana, New York	New York
Estimated miles driven per year	See Details	---	3,996/yr
Last reported odometer reading	45,130	45,350	78,410

**CARFAX** Detailed History



**Owner 1**  
Purchased: 2012

Rental Vehicle  
24,728 mi/yr

Date	Mileage	Source	Comments
01/09/2012		NICB	<b>Vehicle manufactured and shipped to New York</b>
02/07/2012	5	New York Inspection Station	<b>Passed safety inspection</b> - Emissions inspection performed
02/28/2012		New York Motor Vehicle Dept. Buffalo, NY	<b>Title issued or updated</b> - Registration issued or renewed - First owner reported - Loan or lien reported - Titled or registered as rental vehicle - Passed safety inspection
08/21/2012		New York Motor Vehicle Dept. Buffalo, NY	<b>Registration issued or renewed</b> - Passed safety inspection
10/11/2012		Damage Report	 <b>Accident reported: minor damage with another motor vehicle</b> - Damage to front



**CARFAX HAS THE MOST ACCIDENT & DAMAGE INFORMATION**

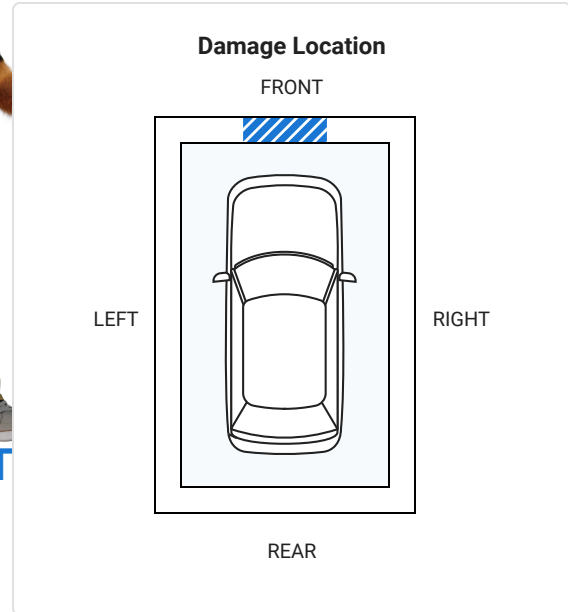
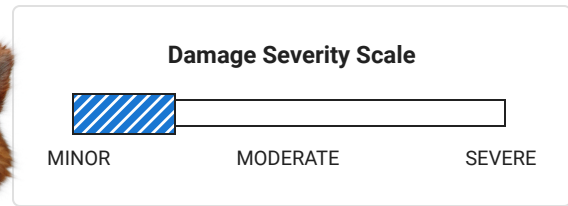

Minor damage is usually cosmetic, including dents or scratches to the vehicle body.

01/18/2013	24,080	New York Inspection Station	<b>Passed safety inspection</b> - Emissions inspection performed
01/28/2013		Enterprise Car Sales Rochester, NY enterprisecarsales.com	<b>Offered for sale as</b> - an Enterprise Certified Used Car - Silver exterior - Gray interior  <b>Certification includes:</b> - 109 point inspection completed - 12 month / 12,000 mile limited powertrain warranty - 1 year unlimited mileage roadside assistance
01/30/2013	24,254	Inspection Co.	<b>Inspection performed</b>
01/30/2013		New York Motor Vehicle Dept. Lockport, NY	<b>Registration issued or renewed</b> - Passed safety inspection







**Owner 2**  
Purchased: 2013







**Low mileage!** This owner drove less than the industry average of 15,000 miles per year.

Personal Vehicle  
6,920 mi/yr

Date	Mileage	Source	Comments
02/22/2013		New York Motor Vehicle Dept. Lockport, NY	<b>Title issued or updated</b> - New owner reported - Loan or lien reported
05/15/2013	28,558	Inspection Co.	<b>Inspection performed</b>
06/11/2013	29,608	Valvoline Instant Oil Change Lockport, NY 716-433-3613 vioc.com ★ 4.9 / 5.0 117 Verified Reviews ❤️ 94 Customer Favorites	 <b>Vehicle serviced</b> - Oil and filter changed
09/04/2013	32,826	Monro Auto Service & Tire Centers Lockport, NY ★ 4.4 / 5.0 11 Verified Reviews	 <b>Vehicle serviced</b> - Exterior lights checked - Oil and filter changed - Exhaust system checked - Exhaust repaired
01/14/2014	37,428	Basil Toyota Lockport, NY 716-625-8444 basiltoyota.com ★ 4.5 / 5.0 204 Verified Reviews ❤️ 1,470 Customer Favorites	 <b>Vehicle serviced</b> - Maintenance inspection completed - Tire condition and pressure checked - Tires rotated - Emissions inspection performed
01/14/2014		New York Inspection Station	<b>Passed safety inspection</b> - Emissions inspection performed
04/21/2014		New York Motor Vehicle Dept. Lockport, NY	<b>Registration issued or renewed</b> - Titled or registered as personal vehicle - Passed safety inspection - Registration updated when owner moved the vehicle to a new location
07/12/2014	40,726	Basil Toyota Lockport, NY 716-625-8444 basiltoyota.com ★ 4.5 / 5.0 204 Verified Reviews ❤️ 1,470 Customer Favorites	 <b>Vehicle serviced</b> - Oil and filter changed
01/26/2015	43,177	New York Inspection Station	<b>Passed safety inspection</b> - Passed emissions inspection

10/06/2015	45,130	Indiana Motor Vehicle Dept. Arlington, TX	<b>Odometer reading reported</b>
10/27/2015		Indiana Motor Vehicle Dept. Arlington, TX Title #15806266000020	<b>Title issued or updated</b> - Vehicle repossessed

 **Owner 3** Personal Lease Vehicle  
Purchased: 2015

Date	Mileage	Source	Comments
11/17/2015		Indiana Motor Vehicle Dept. Arlington, TX Title #15791232000046	<b>Title issued or updated</b> - Correction to record - New owner reported - Titled or registered as personal lease vehicle
			Two states? Vehicle leasing companies often title a car in one state but register it to be driven in another.
12/18/2015		Auto Auction	<b>Vehicle sold</b>
			Millions of used vehicles are bought and sold at auction every year.
12/22/2015		Dealer Inventory	<b>Vehicle offered for sale</b>
01/11/2016	45,153	New York Inspection Station	<b>Passed safety inspection</b> - Failed emissions inspection - Passed emissions inspection
01/12/2016		New York Motor Vehicle Dept. Rochester, NY	<b>Registration issued or renewed</b> - Titled or registered as personal lease vehicle - Passed safety inspection
01/14/2016		Inspection Co.	<b>Inspection performed</b>
01/27/2016	45,350	Bob Johnson Automotive Group Rochester, NY 585-334-9440 bobjohnsonnissan.com/  <b>4.6 / 5.0</b> 514 Verified Reviews	 <b>Vehicle serviced</b> - Maintenance inspection completed - Electrical system checked







**Owner 4**

Purchased: 2016



**Low mileage!** This owner drove less than the industry average of 15,000 miles per year.

Personal Vehicle  
3,996 mi/yr



Date	Mileage	Source	Comments
03/11/2016		New York Motor Vehicle Dept. Rochester, NY	<b>Title issued or updated</b> - New owner reported - Loan or lien reported
09/07/2016	48,232	Pittsford Auto Services Pittsford, NY 585-385-9217 <a href="https://facebook.com/pittsford-auto-service-center-120319427997222/">https://facebook.com/pittsford-auto-service-center-120319427997222/</a>	 <b>Vehicle serviced</b> - Oil and filter changed
10/04/2016	48,995	Pittsford Auto Services Pittsford, NY 585-385-9217 <a href="https://facebook.com/pittsford-auto-service-center-120319427997222/">https://facebook.com/pittsford-auto-service-center-120319427997222/</a>	 <b>Vehicle serviced</b> - Brake rotor(s) replaced
02/17/2017		New York Motor Vehicle Dept. Rochester, NY	<b>Registration issued or renewed</b> - Titled or registered as personal vehicle - Passed safety inspection
02/23/2017	50,862	New York Inspection Station	<b>Passed safety inspection</b> - Passed emissions inspection
04/18/2017	51,542	Pittsford Auto Services Pittsford, NY 585-385-9217 <a href="https://facebook.com/pittsford-auto-service-center-120319427997222/">https://facebook.com/pittsford-auto-service-center-120319427997222/</a>	 <b>Vehicle serviced</b> - Fluids checked - Oil and filter changed
06/29/2017	52,453	Hoselton Toyota East Rochester, NY 585-381-8530 hoseltontoyota.com  ★ <b>4.6 / 5.0</b> 173 Verified Reviews ❤️ <b>115</b> Customer Favorites	 <b>Vehicle serviced</b> - Maintenance inspection completed
01/09/2018		Damage Report	 <b>Damage reported: minor damage</b> - Damage to rear

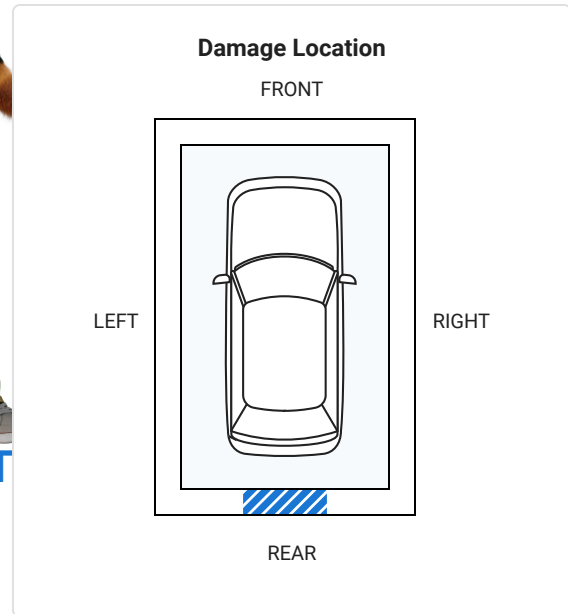
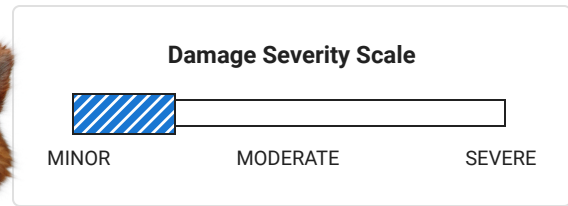

**CARFAX HAS THE MOST ACCIDENT & DAMAGE INFORMATION**



Minor damage is usually cosmetic, including dents or scratches to the vehicle body.

02/01/2018	55,283	Pittsford Auto Services Pittsford, NY 585-385-9217 <a href="https://facebook.com/pittsford-auto-service-center-120319427997222/">https://facebook.com/pittsford-auto-service-center-120319427997222/</a>		<b>Vehicle serviced</b>
02/01/2018		New York Inspection Station		<b>Passed safety inspection</b> - Passed emissions inspection
06/26/2018	56,925	Pittsford Auto Services Pittsford, NY 585-385-9217 <a href="https://facebook.com/pittsford-auto-service-center-120319427997222/">https://facebook.com/pittsford-auto-service-center-120319427997222/</a>		<b>Vehicle serviced</b> - Oil and filter changed
01/31/2019	59,391	Pittsford Auto Services Pittsford, NY 585-385-9217 <a href="https://facebook.com/pittsford-auto-service-center-120319427997222/">https://facebook.com/pittsford-auto-service-center-120319427997222/</a>		<b>Vehicle serviced</b> - Oil and filter changed - Air filter replaced - Emissions or safety inspection performed



		center- 120319427997222/	
01/31/2019		New York Inspection Station	<b>Passed safety inspection</b> - Passed emissions inspection
02/21/2019		New York Motor Vehicle Dept. Rochester, NY	<b>Registration issued or renewed</b> - Titled or registered as personal vehicle - Passed safety inspection
05/28/2019	60,712	Pittsford Auto Services Pittsford, NY 585-385-9217 <a href="https://facebook.com/pittsford-auto-service-center-120319427997222/">https://facebook.com/pittsford-auto-service-center-120319427997222/</a>	 <b>Vehicle serviced</b> - Battery replaced
01/20/2020	63,574	New York Inspection Station	<b>Passed safety inspection</b> - Passed emissions inspection
03/01/2021		New York Motor Vehicle Dept. Rochester, NY	<b>Registration issued or renewed</b> - Titled or registered as personal vehicle - Passed safety inspection
03/04/2021	67,758	New York Inspection Station	<b>Passed safety inspection</b> - Passed emissions inspection
04/01/2022	72,222	New York Inspection Station	<b>Passed safety inspection</b> - Passed emissions inspection
02/17/2023		New York Motor Vehicle Dept. Rochester, NY	<b>Registration issued or renewed</b> - Titled or registered as personal vehicle - Passed safety inspection
05/15/2023	76,024	New York Inspection Station	<b>Passed safety inspection</b> - Passed emissions inspection
03/25/2024	78,410	New York Inspection Station	<b>Passed safety inspection</b> - Passed emissions inspection

Have Questions? Consumers, please visit our Help Center at [www.carfax.com](http://www.carfax.com). Dealers or Subscribers, please visit our Help Center at [www.carfaxonline.com](http://www.carfaxonline.com).



## Glossary

### Accident Indicator

CARFAX receives information about accidents in all 50 states, the District of Columbia and Canada.

Not every accident is reported to CARFAX. As details about the accident become available, those additional details are added to the CARFAX Vehicle History Report. CARFAX recommends that you have this vehicle inspected by a qualified mechanic.

- According to the National Safety Council, Injury Facts, 2021 edition, 5% of the 276 million registered vehicles in the U.S. were involved in an accident in 2019. Over 77% of these were considered minor or

moderate.

- This CARFAX Vehicle History Report is based only on information supplied to CARFAX and available as of 7/9/24 at 2:42:50 PM (CDT). Other information about this vehicle, including problems, may not have been reported to CARFAX. Use this report as one important tool, along with a vehicle inspection and test drive, to make a better decision about your next used car.

### **Damage Indicator**

Damage can be a result of many different types of events. Examples include contact with objects (other cars, trees, traffic signs, road debris, etc), vandalism, or weather-related events. Not every damage event is reported to CARFAX. As details about the damage event become available, those additional details are added to the CARFAX Vehicle History Report. CARFAX recommends that you have this vehicle inspected by a qualified mechanic.

- This CARFAX Vehicle History Report is based only on information supplied to CARFAX and available as of 7/9/24 at 2:42:50 PM (CDT). Other information about this vehicle, including problems, may not have been reported to CARFAX. Use this report as one important tool, along with a vehicle inspection and test drive, to make a better decision about your next used car.

### **Damage Severity**

Damage events result in one of the following severity levels:

- Minor: Generally, minor damage is cosmetic (including dents or scratches), may only require reconditioning, and typically does not compromise a vehicle's operation and/or safety.
- Moderate: Moderate damage may affect multiple components of the vehicle and may impair the vehicle's operation and/or safety.
- Severe: Severe damage usually affects multiple components of the vehicle and is likely to compromise the vehicle's operation and/or safety.

CARFAX recommends getting a pre-purchase inspection at a certified collision repair facility.

### **Failed Emissions Inspection**

The emissions check performed during a vehicle inspection indicated the vehicle was emitting more than allowable emissions standards and/or had missing or modified parts. Repeated failed emissions records can indicate engine problems and CARFAX recommends you have the vehicle inspected.

### **First Owner**

When the first owner(s) obtains a title from a Department of Motor Vehicles as proof of ownership.

### **New Owner Reported**

When a vehicle is sold to a new owner, the Title must be transferred to the new owner(s) at a Department of Motor Vehicles.

### **Ownership History**

CARFAX defines an owner as an individual or business that possesses and uses a vehicle. Not all title transactions represent changes in ownership. To provide estimated number of owners, CARFAX proprietary technology analyzes all the events in a vehicle history. Estimated ownership is available for vehicles manufactured after 1991 and titled solely in the US including Puerto Rico. Dealers sometimes opt to take ownership of a vehicle and are required to in the following states: Maine, Massachusetts, New Jersey, Ohio, Oklahoma, Pennsylvania and South Dakota. Please consider this as you review a vehicle's estimated ownership history.

### **Rental**

Vehicle was registered by a rental agency.

### **Repossession**

When a repossession occurs a vehicle owner fails to make loan payments, and the financial institution holding the title takes possession of the vehicle.

### **Title Issued**

A state issues a title to provide a vehicle owner with proof of ownership. Each title has a unique number. Each title or registration record on a CARFAX report does not necessarily indicate a change in ownership. In Canada, a registration and bill of sale are used as proof of ownership.

### **Toyota Recall / Service Campaign**

Portions of this report have been included under license from Toyota Motor North America, Inc. ("TOYOTA"), License Agreement TMS1013 . This data applies only to vehicle marketed or originally sold in Mexico and the United States of America, including Guam, Saipan, American Samoa, Puerto Rico, the U.S. Virgin Islands and the other United States territories and protectorates with currently open safety or emissions recalls, or service campaigns. While TOYOTA provides data to Carfax Inc. on a regular basis, this report may not include very recent activity. For the

manufacturer's most current information on recall/campaign activity for any Toyota, Lexus or Scion brand vehicle, you must go to <http://toyota.com/recall> or <http://lexus.com/recall>.

Follow Us:



[facebook.com/CARFAX](https://facebook.com/CARFAX)



[@CARFAXinc](https://twitter.com/CARFAXinc)



About CARFAX

CARFAX DEPENDS ON ITS SOURCES FOR THE ACCURACY AND RELIABILITY OF ITS INFORMATION. THEREFORE, NO RESPONSIBILITY IS ASSUMED BY CARFAX OR ITS AGENTS FOR ERRORS OR OMISSIONS IN THIS REPORT. CARFAX FURTHER EXPRESSLY DISCLAIMS ALL WARRANTIES, EXPRESS OR IMPLIED, INCLUDING ANY IMPLIED WARRANTIES OF MERCHANTABILITY OR FITNESS FOR A PARTICULAR PURPOSE.

© 2024 CARFAX, Inc., part of S&P Global. All rights reserved.  
7/9/24 2:42:50 PM (CDT)

**I have reviewed and received a copy of the CARFAX Vehicle History Report for this 2012 TOYOTA RAV4 vehicle (VIN: 2T3BF4DV6CW182453), which is based on information supplied to CARFAX and available as of 7/9/24 at 3:42 PM (EDT).**

---

**Customer Signature**

**Date**

---

**Dealer Signature**

**Date**